

MGAM50S Series

Shaft Type Ø50mm Magnetic Multi-turn Absolute Rotary Encoder

■ Features

- Higher resistant to vibration and impact by magnetic elements than optical encoder
- Total 23-bit resolution (8,388,608-division) of 10-bit single-turn (1,024-division) and 13-bit multi-turn (8,192-revolution)
- Compact size of Ø50mm
- Parallel data/SSI data transmission type
- Maximizing users convenience with over flow alarm (OVF) function
- Power supply: 12-24VDC ±5%
- Protection structure IP50 (IEC standard)

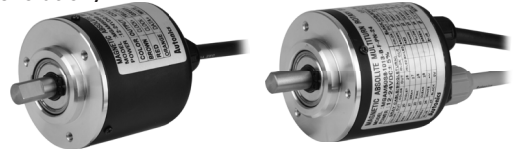

■ Applications

- Precision machine tool, Fabric machinery, Robot, Parking system

⚠ Please read "Safety Considerations" in the instruction manual before using.



■ Ordering Information

MGAM50S	8	10	13	B	F	PN	24
Series	Shaft diameter	Single-turn	Multi-turn	Output code	Rotation direction	Control output	Power supply
Ø50mm Shaft type	Ø8mm	10-bit (1024-division)	13-bit (8192-revolution)	Binary Code	F: Output increases by CW rotation direction at the shaft R: Output increases by CCW rotation direction at the shaft	PN: Parallel NPN open collector output S: SSI Line driver output	12-24VDC±5%

■ Specifications

Type		Shaft Type Ø50mm Magnetic Multi-turn Absolute Rotary Encoder			
Model		MGAM50S8-1013-B-F-S-24	MGAM50S8-1013-B-F-PN-24		
Resolution	Single-turn	1024-division (10-bit)			
	Multi-turn	8192-revolution (13-bit)			
Rotation limit when power off *1		±90°			
Electrical specification	Output	Hysteresis	±0.1°		
		Positioning error*2	±1-bit (LSB: Least Significant Bit)		
		Output code	24-bit, Binary code	Binary code	
		Control output	SSI (Synchronous Serial Interface) Line driver output [Low] - Sink current: max. 20mA, Residual voltage: max. 0.5VDC= [High] - Sink current: max. -20mA, Output voltage: min. 2.5VDC= Parallel NPN open collector output Sink current: max. 20mA, Residual voltage: max. 1VDC= Output signal	Single-turn data, multi-turn count, over flow alarm (OVF)*3	
		Output logic	—	Negative logic output	
		Response time (rise, fall)	—	Max. 1µs (cable: 2m, I sink = 20mA)	
		Multi-turn count reset input*4	Input level	0-1VDC= Input logic	
			Input logic	Low Active, Open for common use	
	Input time		Over 100ms		
	SSI clock input	Input level	5VDC= ±5%		
Input frequency		100kHz to 1MHz			
Max. response frequency	—	30kHz			
Power supply	12-24VDC= ±5% (ripple P-P: max. 5%)				
Current consumption	Max. 150mA (disconnection of the load)		Max. 100mA (disconnection of the load)		
Insulation resistance	Over 100MΩ (at 500VDC megger between all terminals and case)				
Dielectric strength	750VAC 50/60Hz for 1 minute (between all terminals and case)				
Connection	Axial cable type (cable gland)				

*1: It calibrates the multi-turn counts by comparing single-turn data before/after power off without counting multi-turn counts when power is off. It shall be used on the condition that no overrated revolution occurred since proper multi-turn counts may not be available if any revolutions occurred over ±90° from the position when power is off.

*2: When turning ON/OFF the unit, there may be ±1-bit (LSB) error at present position by hysteresis.

*3: OVF alarm is ON when multi-turn count is out of counting range (0 to 8191 revolutions).

*4: Multi-turn count shall be initialized as 「0 revolution」 when multi-turn count reset is input.

Absolute Ø50mm Magnetic Multi-turn Shaft Type

Specifications

Type		Shaft Type Ø50mm Magnetic Multi-turn Absolute Rotary Encoder	
Model		MGAM50S8-1013-B-F-S-24	MGAM50S8-1013-B-F-PN-24
Mechanical specification	Starting torque	Max. 70gf·cm (0.0069N·m)	
	Moment of inertia	Max. 80g·cm ² (8×10 ⁻⁶ kg·m ²)	
	Shaft loading	Radial: max. 10kgf, Thrust: max. 2.5kgf	
	Max. allowable revolution*5	3,000rpm	
Vibration		1.5mm amplitude at frequency of 10 to 55Hz (for 1 min) in each X, Y, Z direction for 2 hours	
Shock		Approx. max. 50G	
Environment	Ambient temp.	-10 to 70°C, storage: -25 to 85°C	
	Ambient humid.	35 to 85%RH, storage: 35 to 90%RH	
Protection structure		IP50 (IEC standard)	
Cable		Ø6mm, 10-wire, 2m, Shield cable (AWG 28, core diameter: 0.08mm, number of cores: 19, insulator out diameter: Ø0.8mm)	Ø6mm, 17-wire×2, 2m, Shield cable (AWG 28, core diameter: 0.08mm, number of cores: 17, insulator out diameter: Ø0.8mm)
Accessories		Bracket, coupling	
Approval		CE	
Weight*6		Approx. 391g (approx. 261g)	Approx. 523g (approx. 393g)

※5: In case of Parallel type model, Make sure that Max. response revolution should be lower than or equal to max. allowable revolution when selecting the resolution.

$$\text{【Max. response revolution (rpm) = } \frac{\text{Max. response frequency} \times 60 \text{ sec}}{\text{Resolution}} \text{】}$$

※6: The weight includes packaging. The weight in parenthesis is for unit only.

※Environment resistance is rated at no freezing or condensation.

Synchronous Serial Interface (SSI) Output Timing Diagram

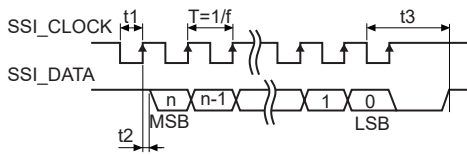

Clock Frequency f	100kHz to 1MHz
T	T: 1 to 10µs
Time lag t2	t2 < 0.3µs
Monoflop Time t3	15µs < t3 < 30µs

Synchronous Serial Interface (SSI) Data Output

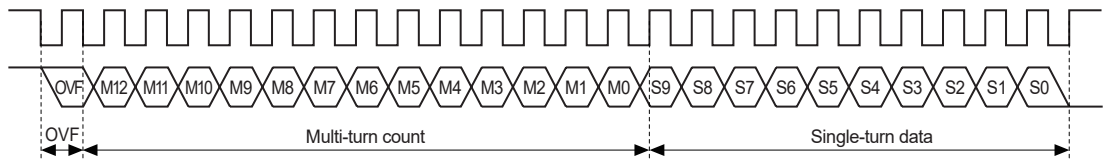

Clock input bit	Data output name	Data output bit	Clock input bit	Data output name	Data output bit
1	Over flow alarm bit	0-bit	15	Single-turn data	9-bit (MSB)
2	Multi-turn count	12-bit (MSB)	16		8-bit
3		11-bit	17		7-bit
4		10-bit	18		6-bit
5		9-bit	19		5-bit
6		8-bit	20		4-bit
7		7-bit	21		3-bit
8		6-bit	22		2-bit
9		5-bit	23		1-bit
10		4-bit	24		0-bit (LSB)
11		3-bit			
12		2-bit			
13		1-bit			
14		0-bit (LSB)			

SENSORS

CONTROLLERS

MOTION DEVICES

SOFTWARE

(A) Photoelectric Sensors

(B) Fiber Optic Sensors

(C) LIDAR

(D) Door/Area Sensors

(E) Vision Sensors

(F) Proximity Sensors

(G) Pressure Sensors

(H) Rotary Encoders

(I) Connectors/ Connector Cables/ Sensor Distribution Boxes/ Sockets

MGAM50S Series

■ Parallel Interface 1024-division Single-turn Data Output Waveform

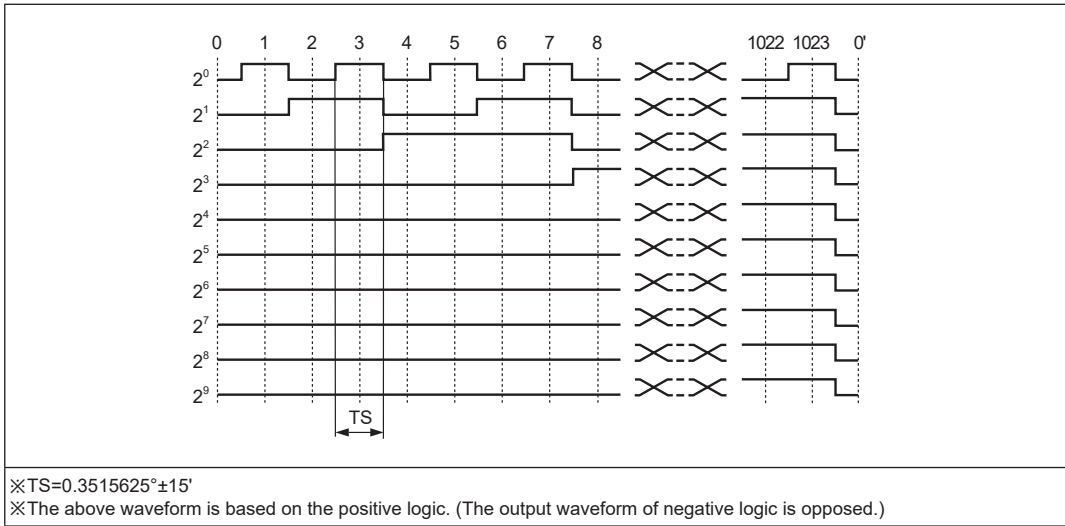

■ Parallel Interface 8192-revolution Multi-turn Count Data Output Waveform

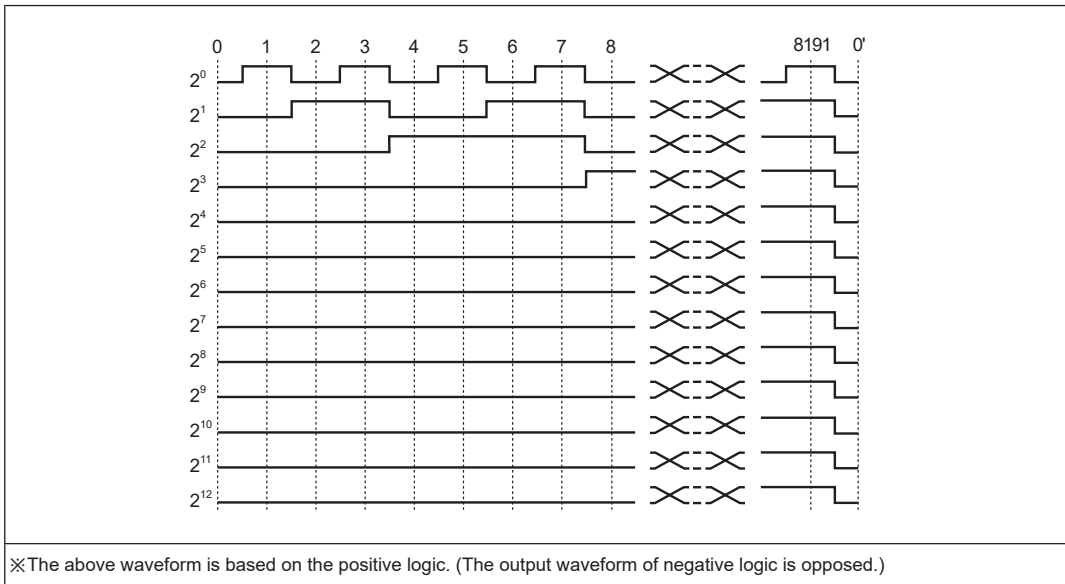

■ Control Output I/O Circuit

◎ SSI Line driver output type

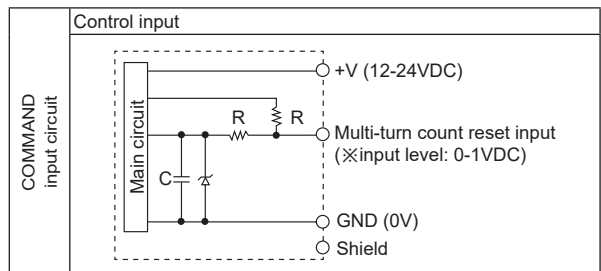
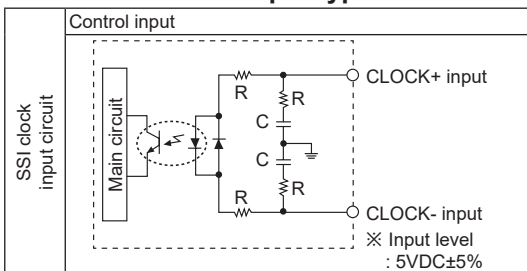

Absolute Ø50mm Magnetic Multi-turn Shaft Type

Control Output I/O Circuit

SSl Line driver output type

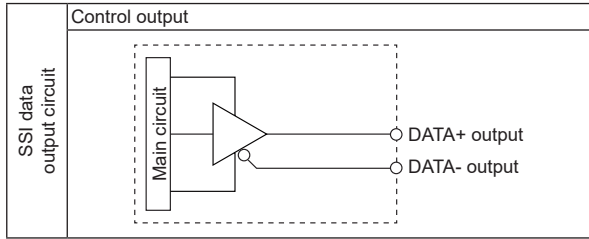

Parallel NPN open collector output type

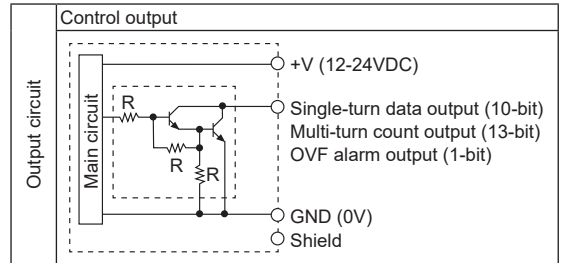
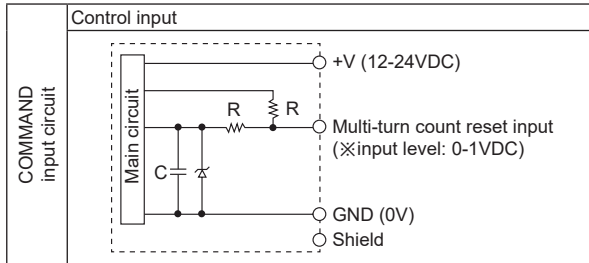

※Each bit of output has the same circuit.

※Please be aware of the fact that overload and short circuit may cause circuit break.

Connections

SSl Line driver output type

Cable		Cable	
Cable color	Description	Cable color	Description
Brown	SSI	Green	COMMAND
Red		Blue	
Orange		Purple	
Yellow		Gray	
White	+V (12-24VDC)	Shield	Signal shield cable (F.G.)
Black	GND (0V)	—	—

Parallel NPN open collector output type

Multi-turn count cable (sheath color: black)		
Cable color	Description	
Brown	Multi-turn count	2 ⁰
Red		2 ¹
Orange		2 ²
Yellow		2 ³
Green		2 ⁴
Blue		2 ⁵
Purple		2 ⁶
Gray		2 ⁷
Pink		2 ⁸
Clear		2 ⁹
Light brown		2 ¹⁰
Light yellow		2 ¹¹
Light green	2 ¹²	
Light blue	OVF	
Light purple	Multi-turn count reset	
White	N.C.	
Black	N.C.	
Shield	Signal shield cable (F.G.)	

Single-turn data cable (sheath color: gray)		
Cable color	Description	
Brown	Single-turn data	2 ⁰
Red		2 ¹
Orange		2 ²
Yellow		2 ³
Green		2 ⁴
Blue		2 ⁵
Purple		2 ⁶
Gray		2 ⁷
Pink		2 ⁸
Clear	2 ⁹	
Light brown	N.C.	
Light yellow	N.C.	
Light green	N.C.	
Light blue	N.C.	
Light purple	N.C.	
White	+V (12-24VDC)	
Black	GND (0V)	
Shield	Signal shield cable (F.G.)	

※Unused wires must be insulated.

※Do the wiring properly.

※Encoder metal case and shield cable must be grounded (F.G.).

※Please use caution to avoid short circuit when connecting output cables because I/O circuit uses the dedicated driver IC.

※Do not apply tensile strength over 30N to the cable.

SENSORS

CONTROLLERS

MOTION DEVICES

SOFTWARE

(A) Photoelectric Sensors

(B) Fiber Optic Sensors

(C) LIDAR

(D) Door/Area Sensors

(E) Vision Sensors

(F) Proximity Sensors

(G) Pressure Sensors

(H) Rotary Encoders

(I) Connectors/
Connector Cables/
Sensor Distribution
Boxes/ Sockets

MGAM50S Series

■ Dimensions

(unit: mm)

◎ SSI Line driver output type

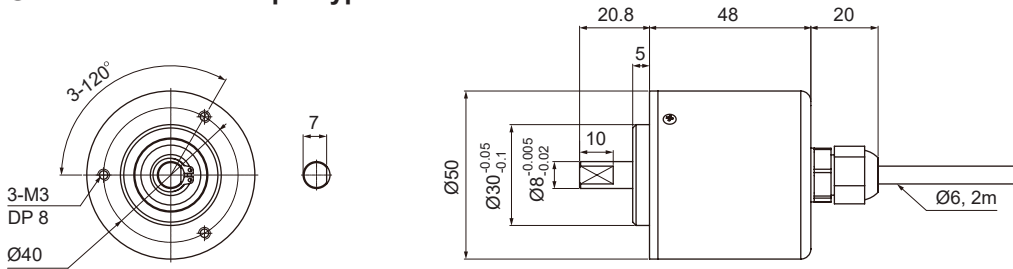

◎ Parallel NPN open collector output type

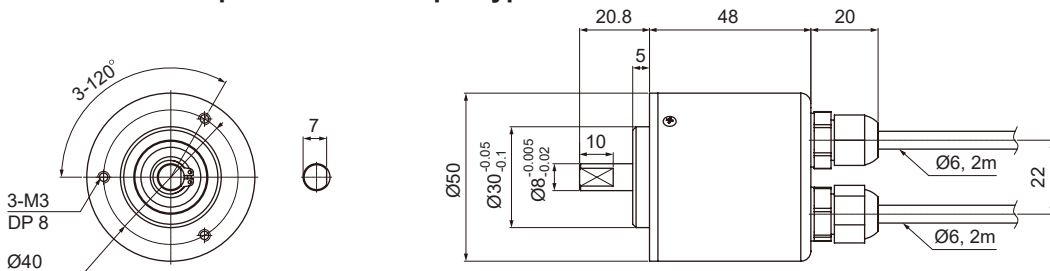

◎ Bracket

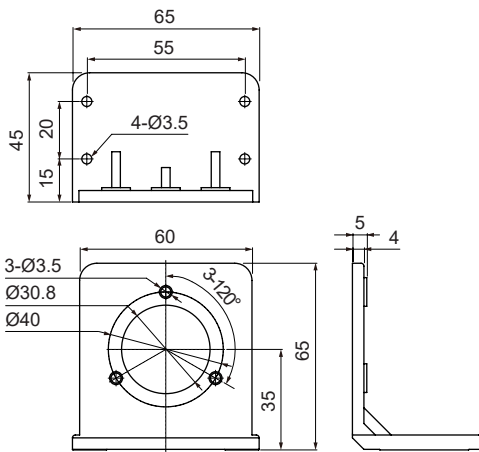

◎ Coupling

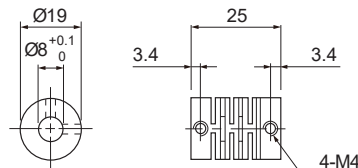

- Parallel misalignment: max. 0.25mm
- Angular misalignment: max. 5°
- End-play: max. 0.5mm

- ※ Do not load overweight on the shaft.
- ※ Do not put strong impact when insert a coupling into shaft.
Failure to follow this instruction may result in product damage.
- ※ Fix the unit or a coupling by a wrench under 0.15N·m of torque.
- ※ When you install this unit, if eccentricity and deflection angle are larger, it may shorten the life cycle of this unit.
- ※ For parallel misalignment, angular misalignment, end-play terms, refer to the "Glossary" section of Technical Description.
- ※ For flexible coupling (ERB series) information, refer to the ERB series section.

■ Functions

◎ Multi-turn count reset

Multi-turn data will be reset as 「0 revolution」 when multi-turn count reset cable (light purple) is inputted 0 to 1V (over 100ms).

◎ Over flow alarm (OVF)

It is an alarm function when multi-turn count is out of rotation ranges (0 to 8191 revolutions).
Over flow alarm is also reset with multi-turn count value when multi-turn count reset signal is inputted.